

LINEA  
220V  
1KVA

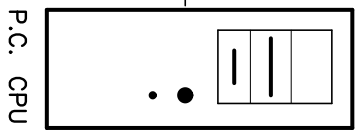

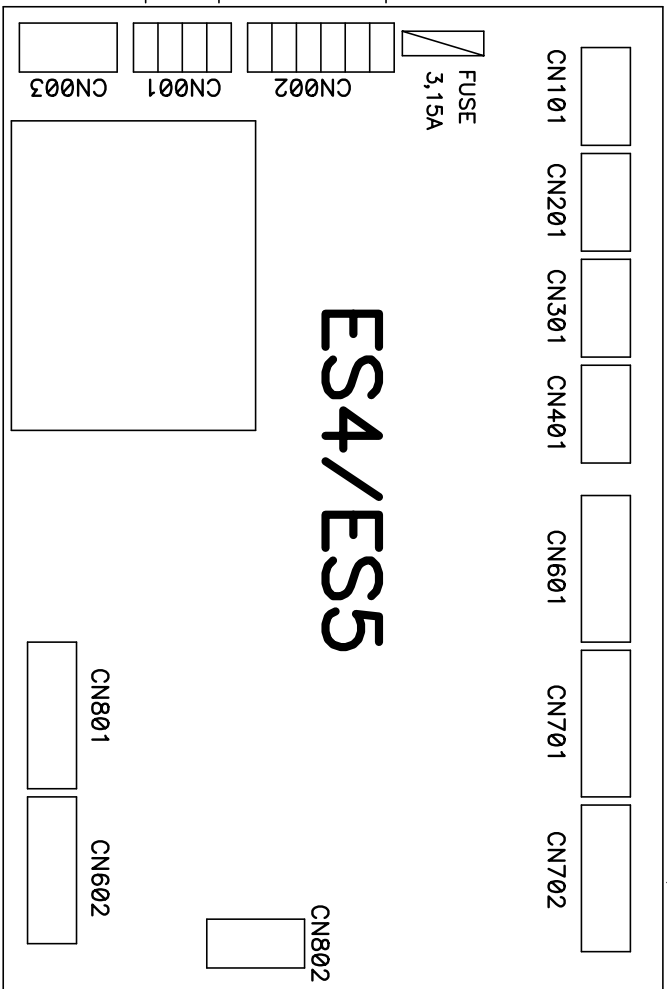
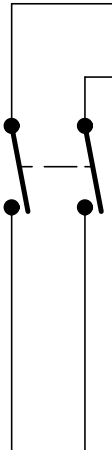
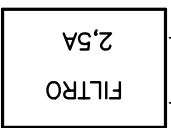
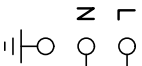
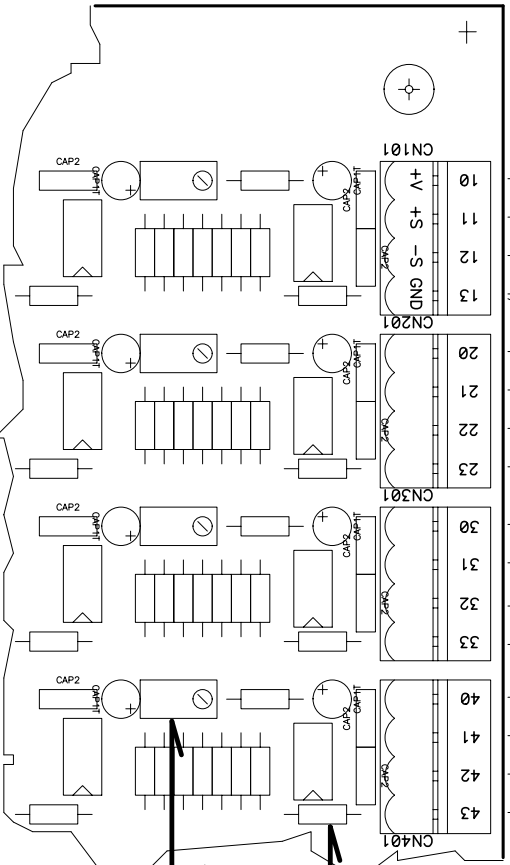
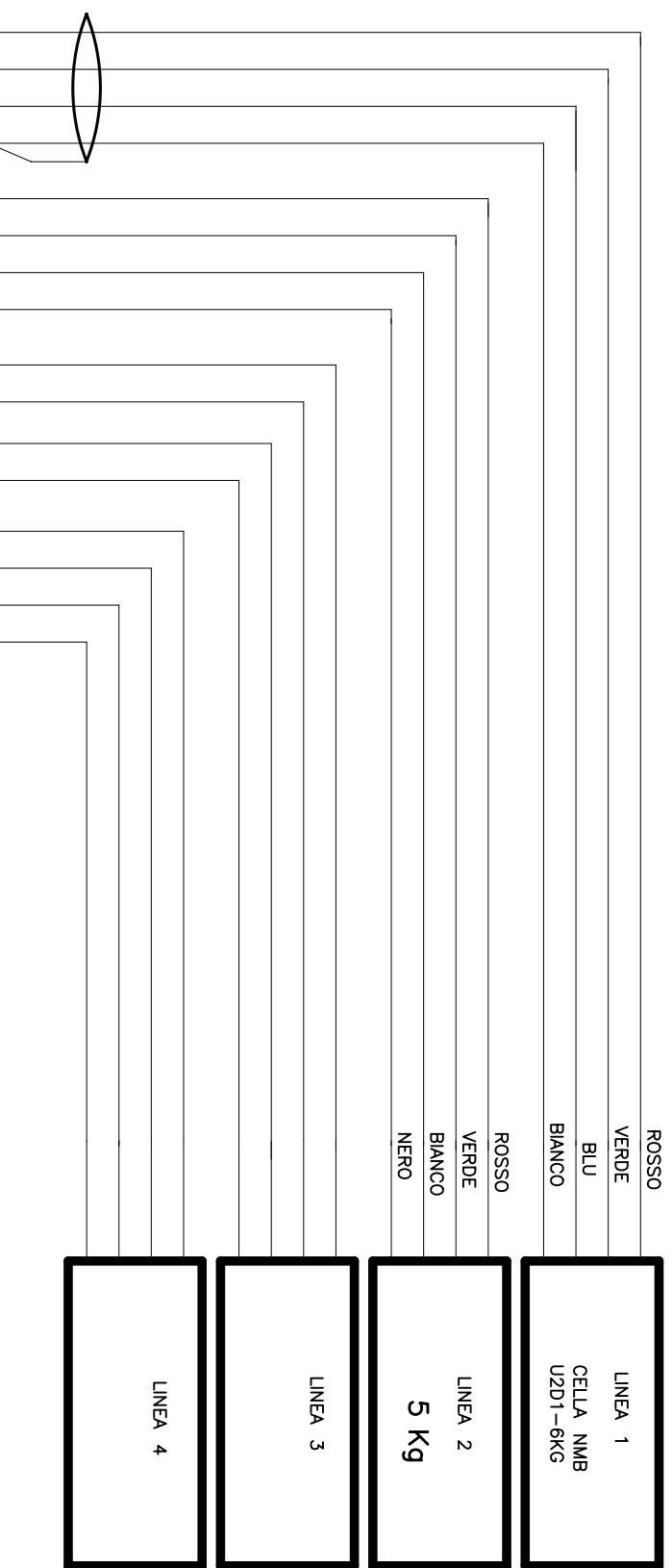

RG 6 Kg 221R  
10 Kg 332R + 100R

TRIMMER REGOLAZIONE 0 (Zero)

+ SENSO ORARIO  
- SENSO ANTIORARIO

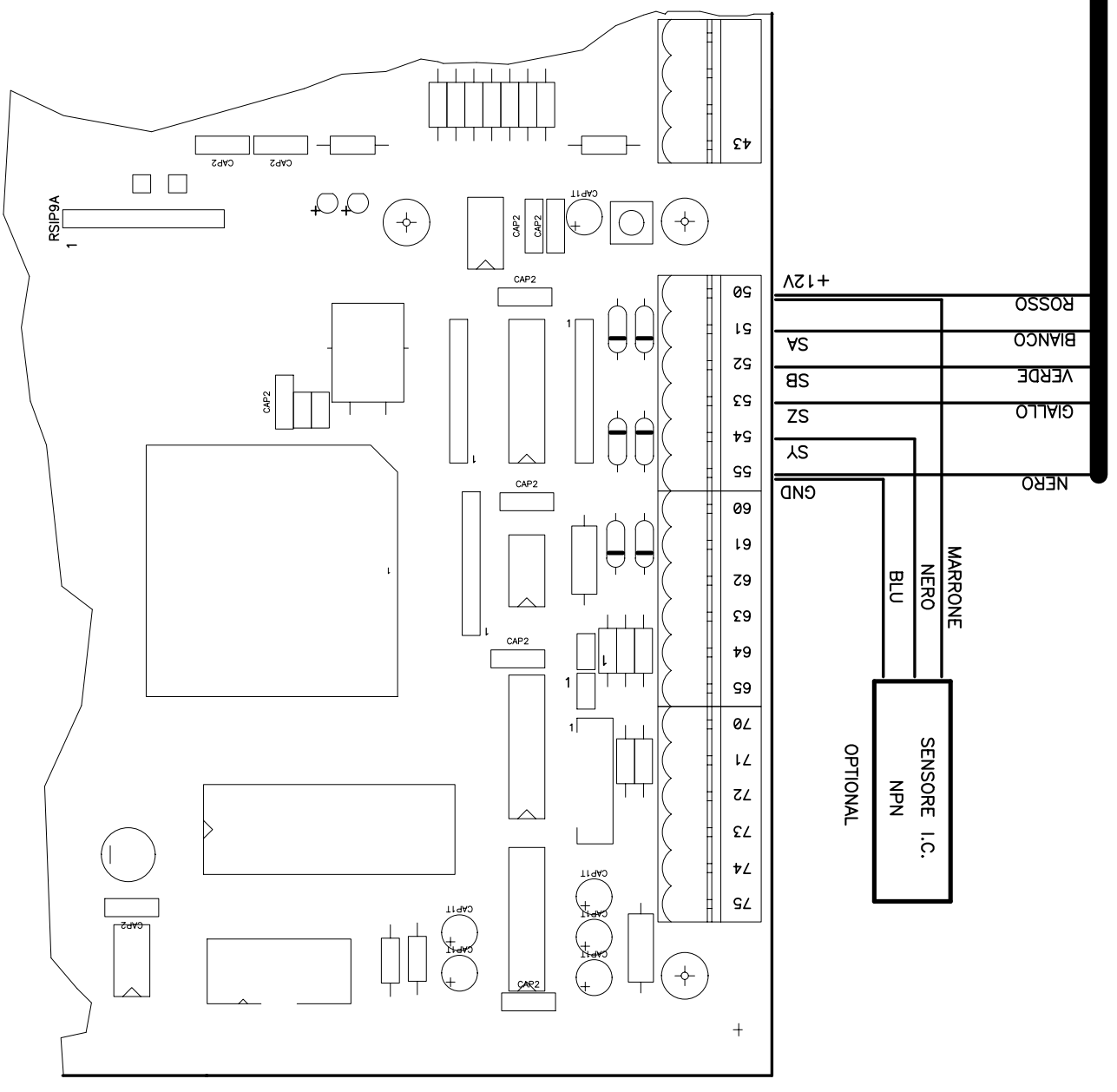
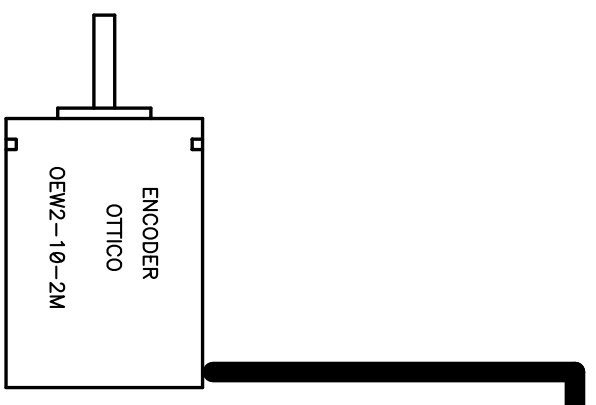

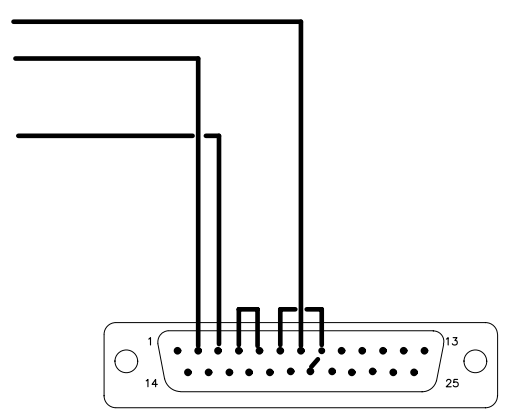
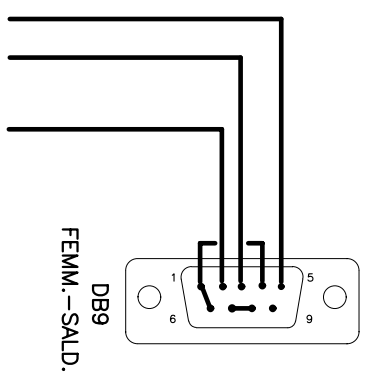
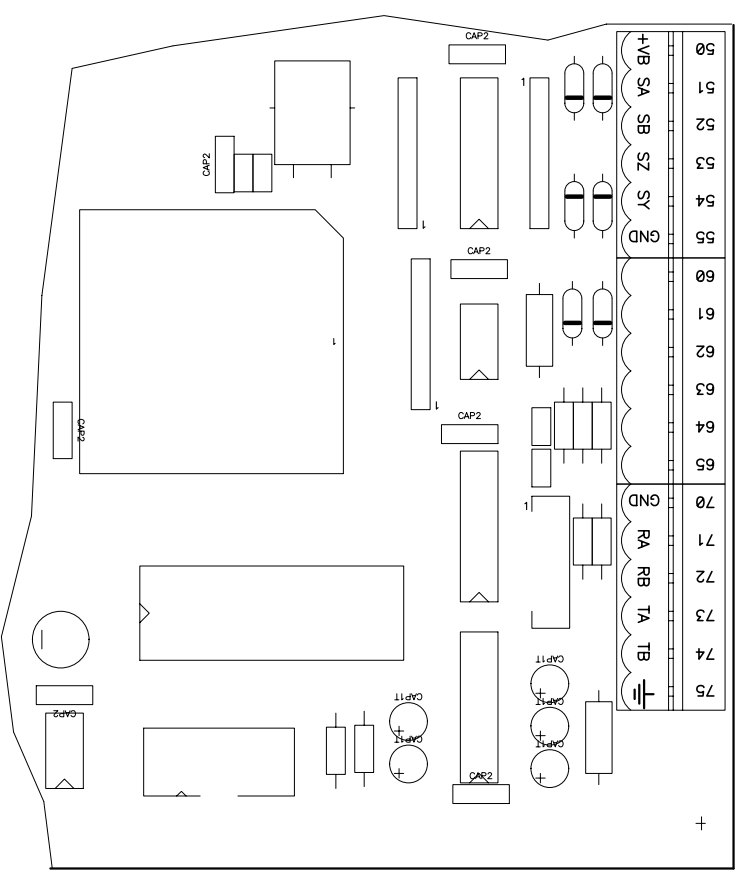
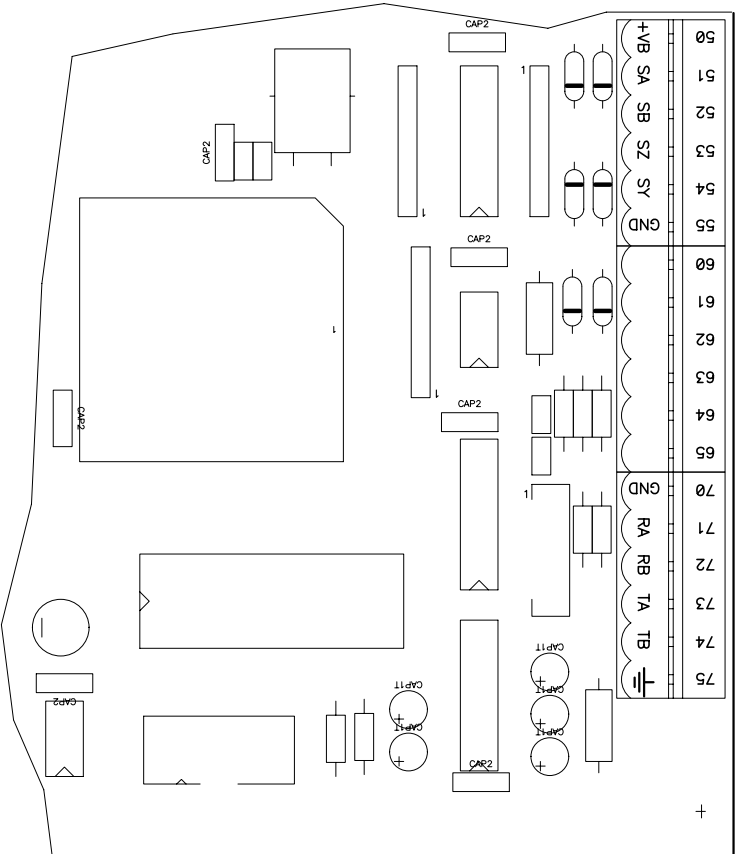

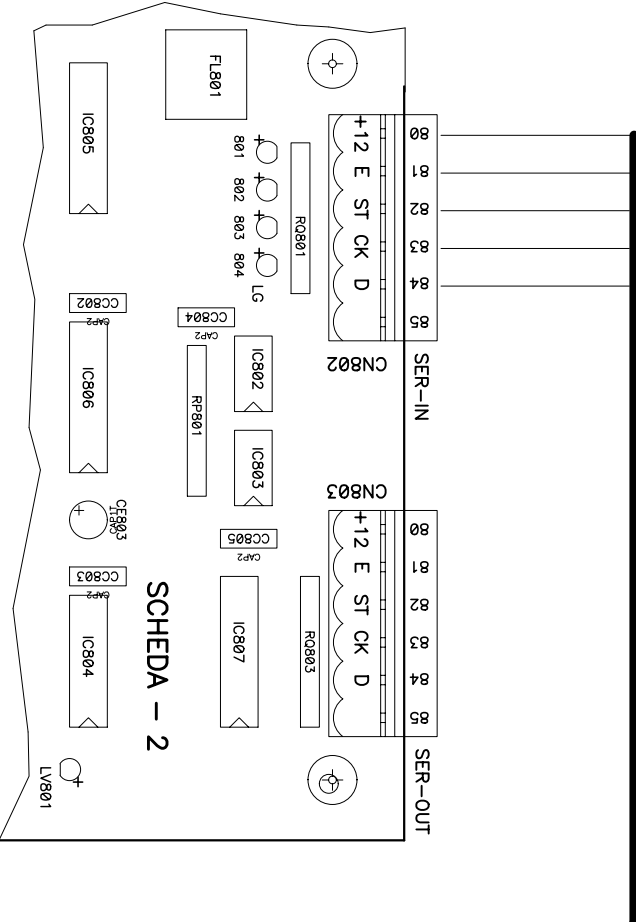
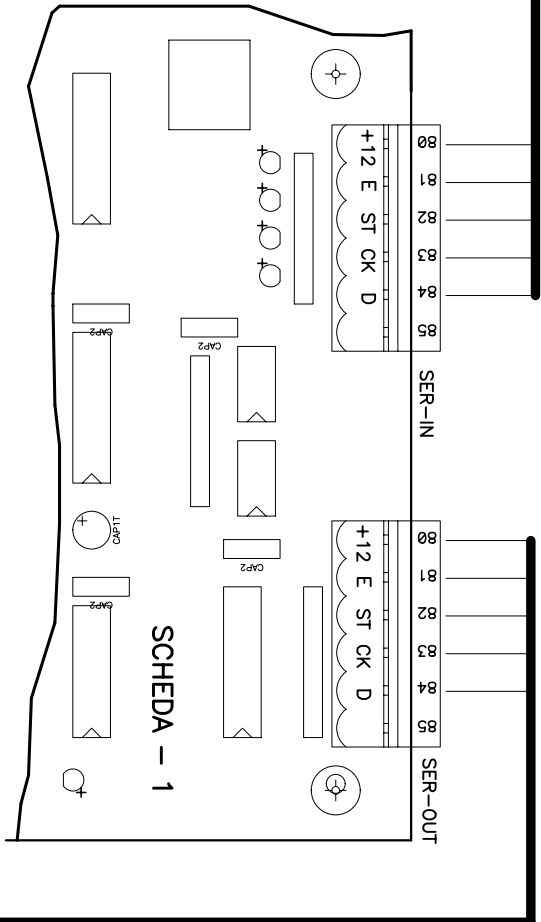
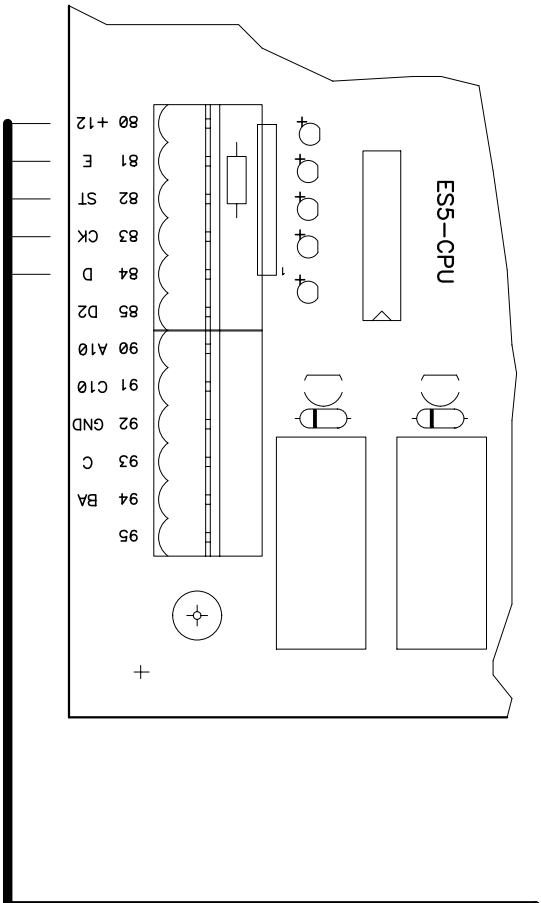

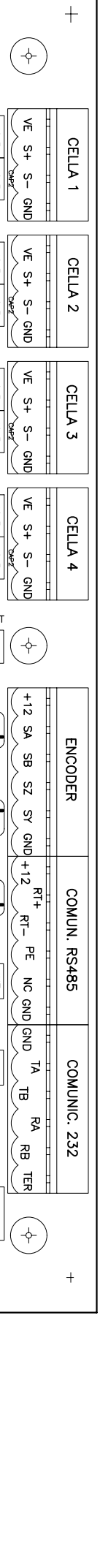

# ES4-V

3,15 A

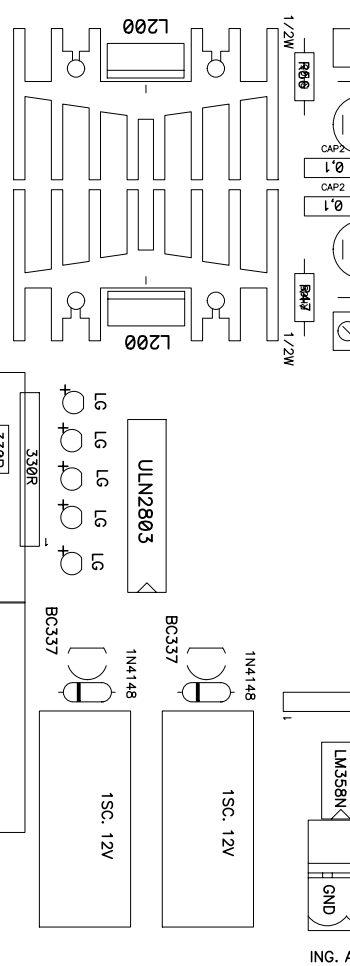
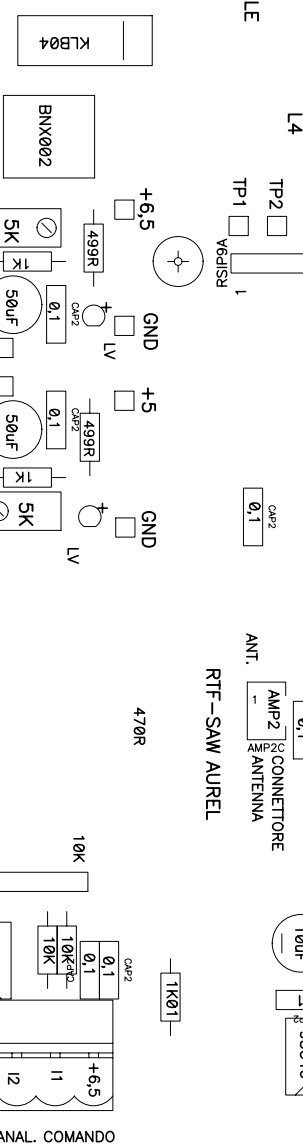
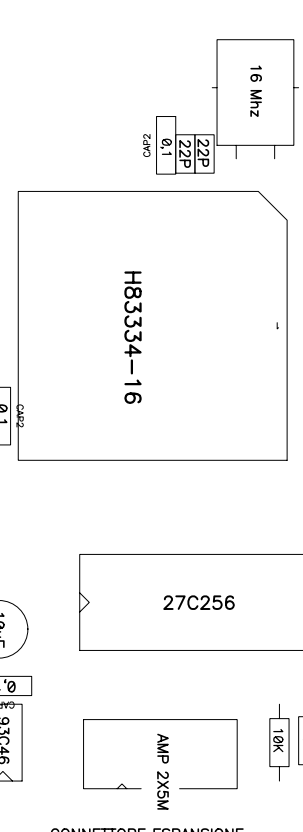
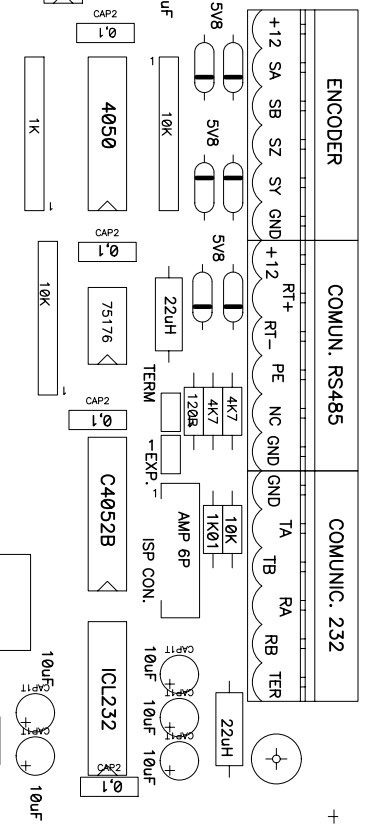
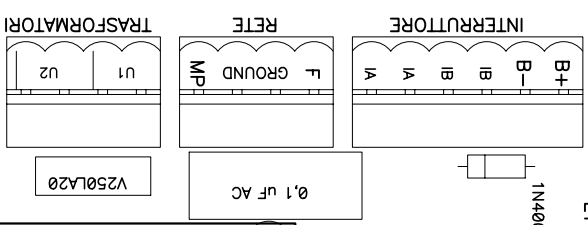
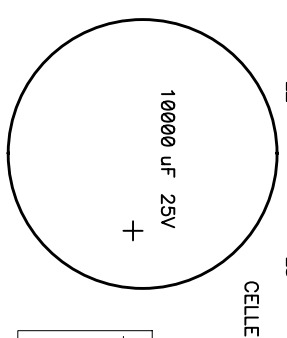
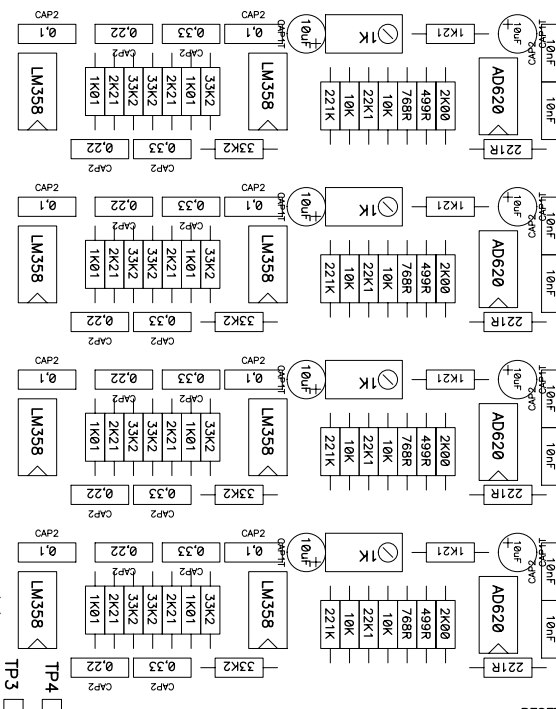

220V 9V/9V 14VA  
RS 209-960

CONFIGURAZIONE A 4 LINEE ( 4 USCITE )

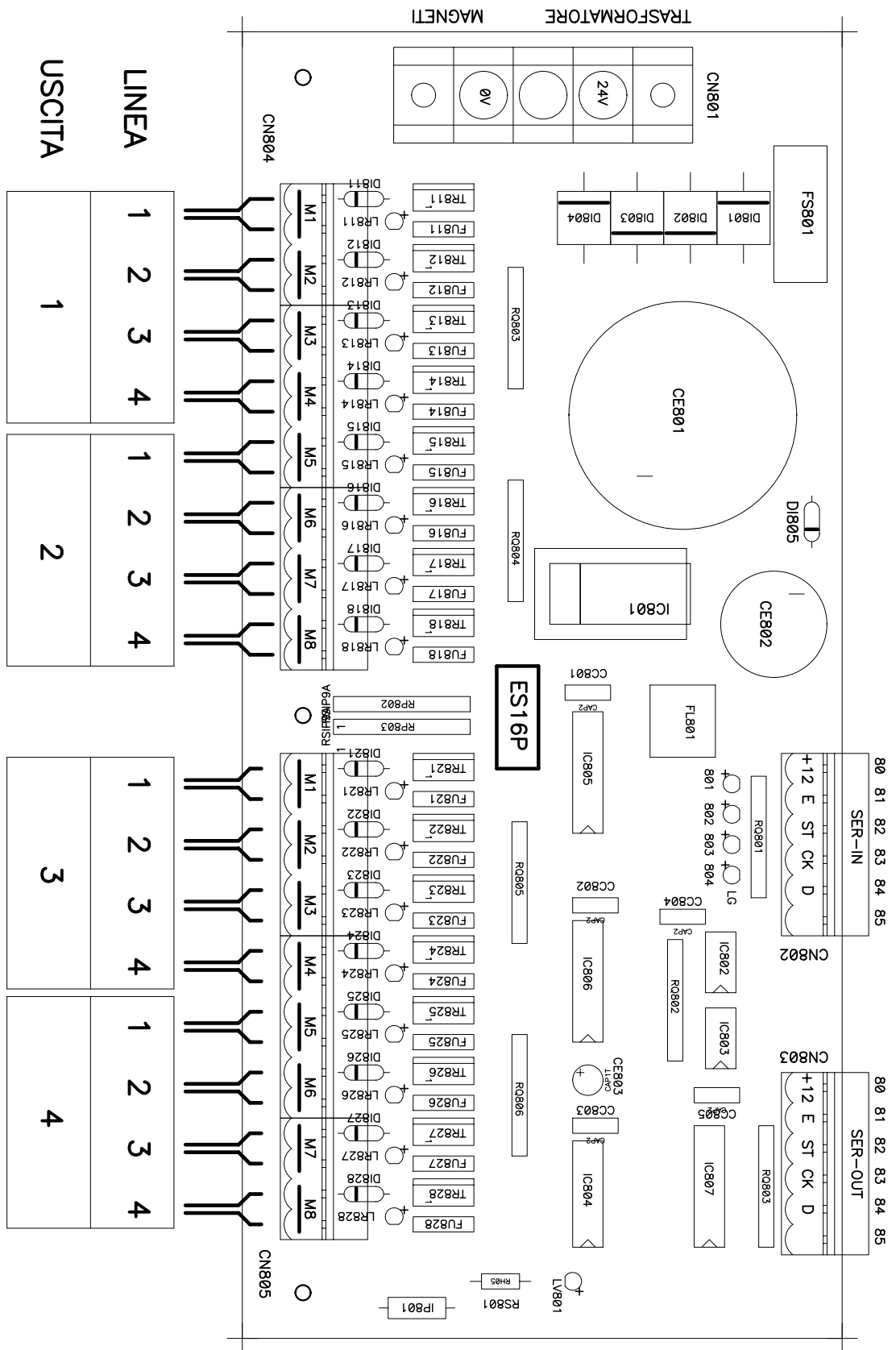



L N X

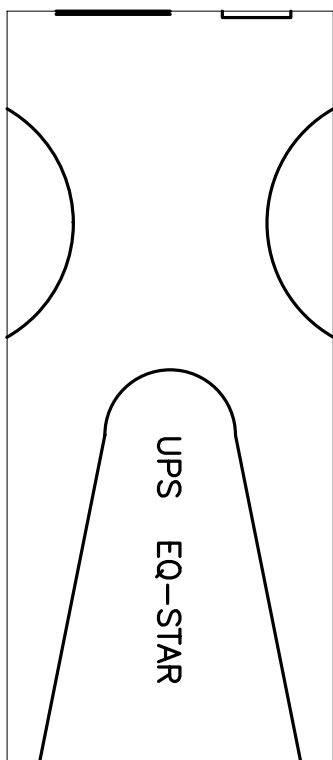
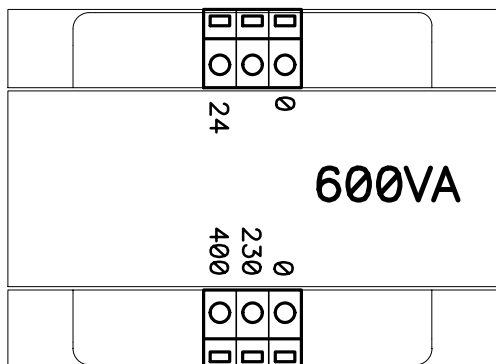
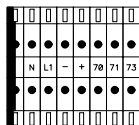
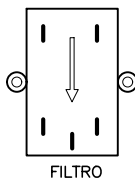

L1 L2 L3 L4 ENCODER RS232

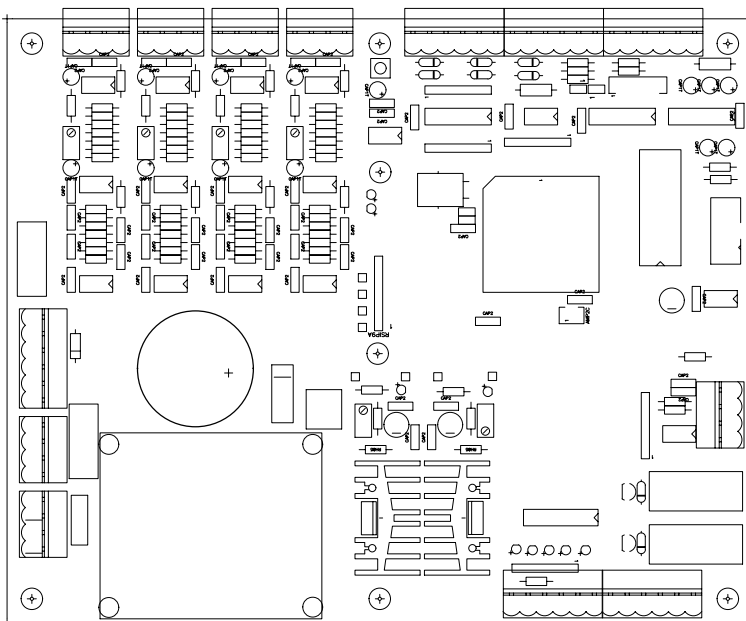

F.C.

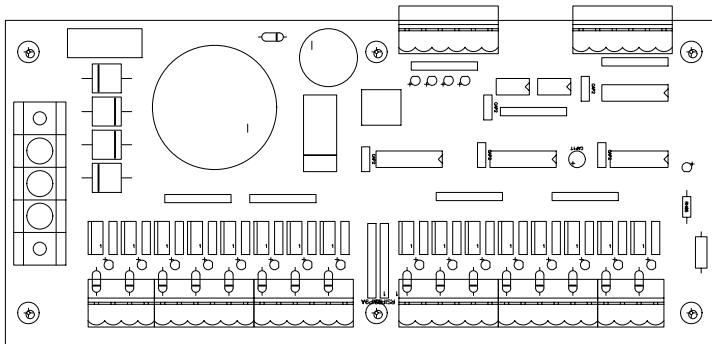

USCITA 1 USCITA 2 USCITA 3 USCITA 4

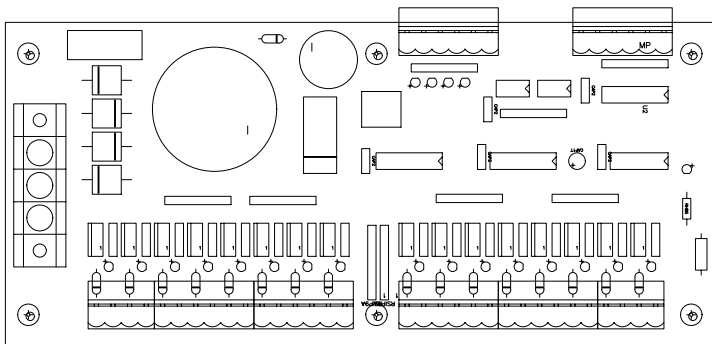

USCITA 5 USCITA 6 USCITA 7 USCITA 8

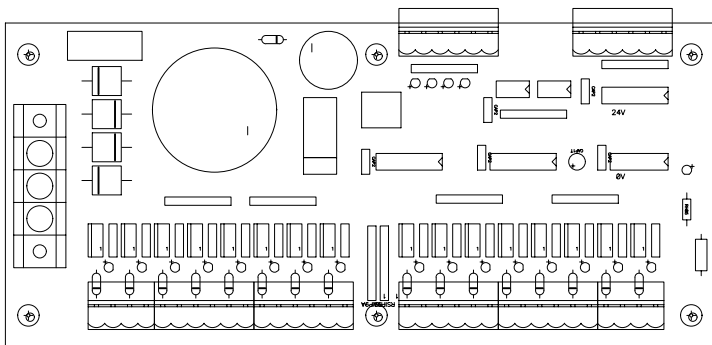

USCITA 9 USCITA 10 USCITA 11 USCITA 12